

CONFIG PART #

910ENT3248MSS-NS

EN FRAME 91"H x 32"W x 48"D WITH 2 PAIR OF 45 RMU #10-32 TAPPED RAILS, CABLE MANAGEMENT FINGERS ON ALL RAILS, SOLID TOP, DUAL HINGE PERF FRONT DOOR, SPLIT PERF REAR DOOR

910EN3248MSS-NS

EN FRAME 91"H x 32"W x 48"D WITH 2 PAIR OF 45 RMU M6 RAILS, CABLE MANAGEMENT FINGERS ON ALL RAILS, SOLID TOP, DUAL HINGE PERF FRONT DOOR, SPLIT PERF REAR DOOR

19" EIA 310-D COMPLIANT  
REF PART # FOR:  
#10-32UNF TAPPED HOLES  
or  
3/8" SQUARE HOLES w/  
M6 HARDWARE

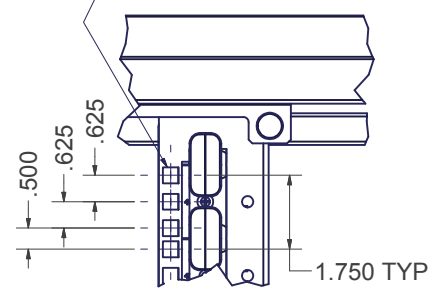

DETAIL C

1.750 TYP LEVELER MTG. LOCATIONS

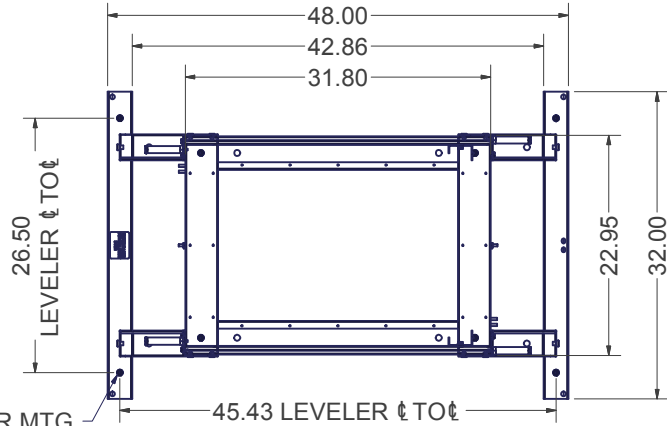

SECTION B-B  
DOORS REMOVED

INDEPENDENT MOUNTING LOCATIONS FOR LADDER RACK BRACKETS OR TOP MOUNTED CABLE TROUGHS

TOP PANEL OPENING (273 sq.in.) SOLID, VENTED, OR w/ EXHAUST FANS FOR UP TO 1100 CFM

5.75 x 17.25 CABLE PASS THROUGH KNOCKOUT (99.2 sq.in.), 2 PLACES

2.63 x 7.25 CABLE PASS THROUGH KNOCKOUTS (19.1 sq.in.), 4 PLACES

2.63 x 27.00 CABLE PASS THROUGH KNOCKOUTS (71 sq.in.), 2 PLACES

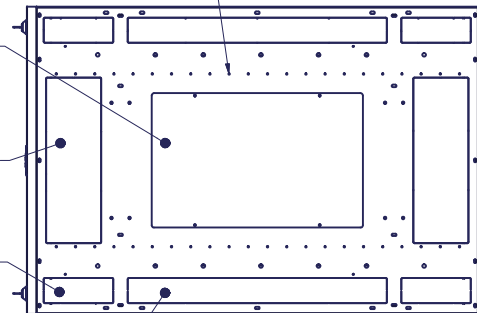

TOP VIEW

SPLIT MESH REAR DOORS PART # 9102EN32SM

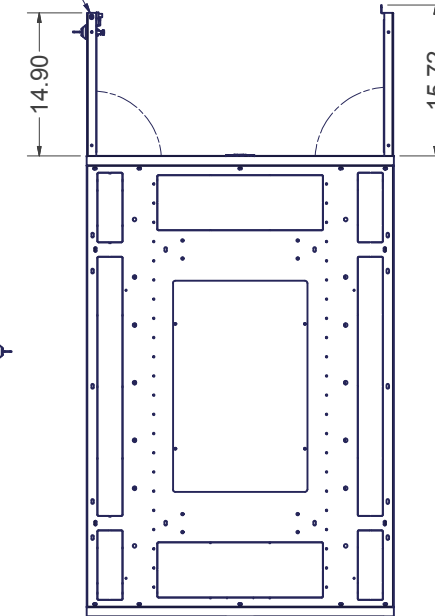

SPLIT MESH FRONT DOOR PART # 9102ENM32

TOP VIEW

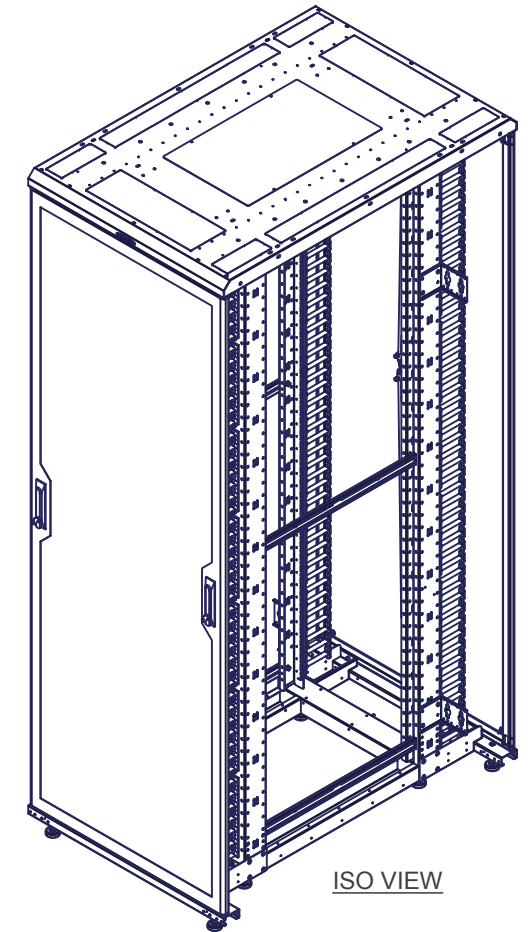

ISO VIEW

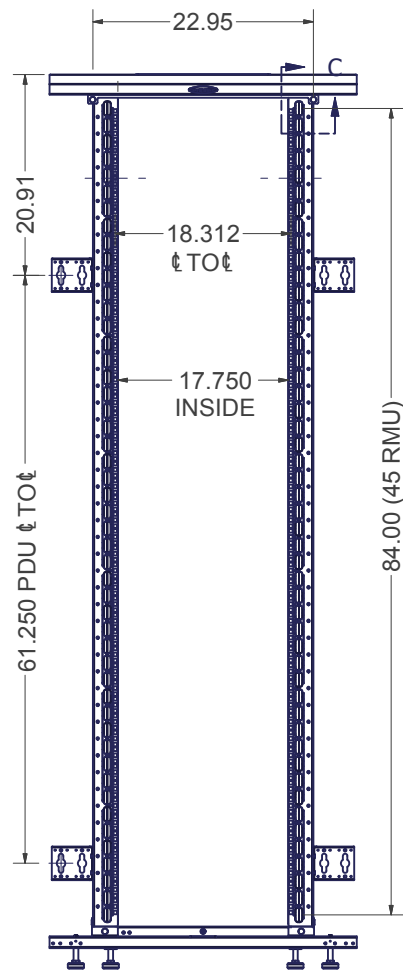

FRONT VIEW  
DOORS REMOVED

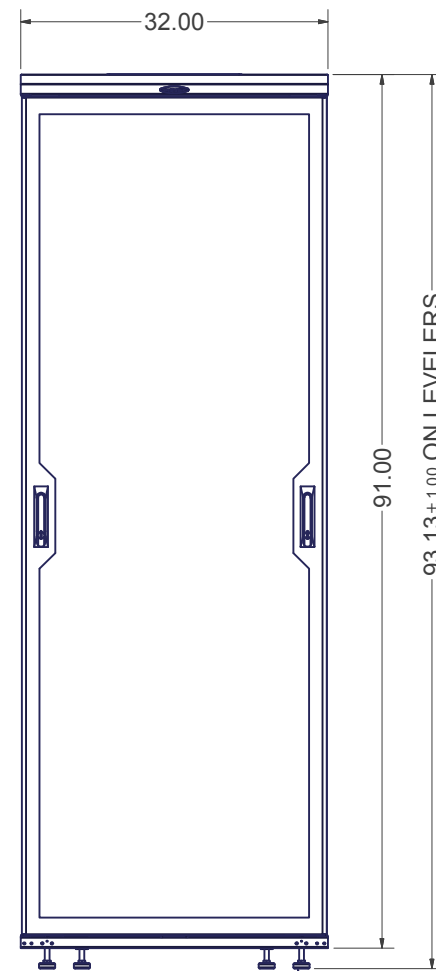

FRONT VIEW

(8) LEVELING GLIDES IN 1/2-13 UNC THREADED HOLES

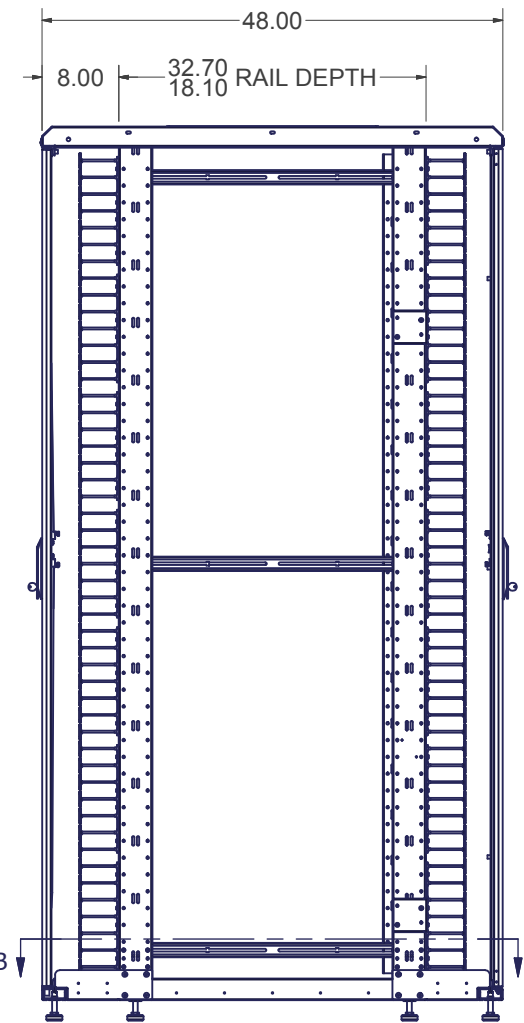

RIGHT SIDE VIEW

**SPECIFICATIONS:**

**CONFIG. # KIT INCLUDES:** QTY. 1 9101ENX3248, BASE FRAME UNIT WITH RAILS  
QTY. 1 9102EN32SM, SPLIT MESH REAR DOOR ASSEMBLY  
QTY. 1 9102ENM32, MESH FRONT DOOR ASSEMBLY

**DIMENSIONS :** 91.0"H x 32.0"W x 48.0"D

**RACK SPACES :** 48 RMU w/ NUMBERED RMU INDICATORS, 19" EIA 310-D COMPLIANT.

**COLOR :** DURABLE TEXTURED BLACK POWDER COATING

**CONSTRUCTION :** FULL WELDED FRAME WITH RECESSED #12 GA CORNER POSTS  
1 PAIR FIXED #12 GA RAILS, 1 PAIR ADJUSTABLE DEPTH #12 GA RAILS  
#16 C.R.S. DOORS & SOLID TOP PANEL

**HARDWARE :** PACKAGE OF QTY-50; #10-32 SCREWS -OR- M6 SCREWS W/ CAGE NUTS, INCLUDED.

EST. WEIGHT :  
348.70 lbmass



INTERPRET DRAWING PER ASME Y14.5M-1994  
DIMENSIONAL LIMITS APPLY AFTER APPLICATION OF FINISH  
DRAWING NOT TO SCALE  
TOLERANCE UNLESS OTHERWISE NOTED:  
ANGULAR +/- .1"  
.XXXX +/- .010  
.XXX +/- .015  
.XX +/- .030  
.X FOR REF. ONLY

UNLESS OTHERWISE SPECIFIED ALL DIMENSIONS ARE IN INCHES

**NOTICE:**

Use of this document is subject to a confidentiality and nondisclosure agreement with Great Lakes Case & Cabinet Co., Inc. (GLCC) and may not be reproduced, disclosed or utilized in whole or in part without prior written authorization from GLCC.

PART NUMBER: 910EN3248MSS-NS  
QTY PER UNIT: 1  
MATERIAL TYPE:  
MATERIAL GAUGE:  
FINISH:  
DRAWN: DATE: 5/15/2014  
FED: DATE:  
CHECKED & APP. DATE: 2/9/2011  
WSS

TITLE: EN FRAME, 91"H x 32"W x 48"D w/ SOLID TOP, DUAL HINGE PERF FRONT DOOR, SPLIT PERF REAR DOOR & 48 RU RAILS  
GREAT LAKES CASE & CABINET CO., INC.  
P.O. BOX 551 EDINBORO, PA 16412  
PHONE (814) 734-7303 FAX (814) 734-3907  
E-MAIL glcc@greatcabinets.com

DWG NO. REV. SEE CHART SHEET: 1 OF 1