

**CONSTRUCTION:**

- VARIABLE RAIL DEPTH FROM 24"-36" IN 1" INCREMENTS
- BOLT TOGETHER CONSTRUCTION, SHIPS FLAT AS KIT
- STEEL COMPONENTS - DURABLE TEXTURE POWDERCOAT
- 12 GA. C.R.S. VERTICAL UPRIGHTS
- 7 GA. C.R.S. HORIZONTAL FOOT BRACKET
- 14 GA. C.R.S. CROSS MEMBERS
- 14 GA. C.R.S. EXTENSION BARS
- 12 GA. C.R.S. TOP WIDTH BRACKETS

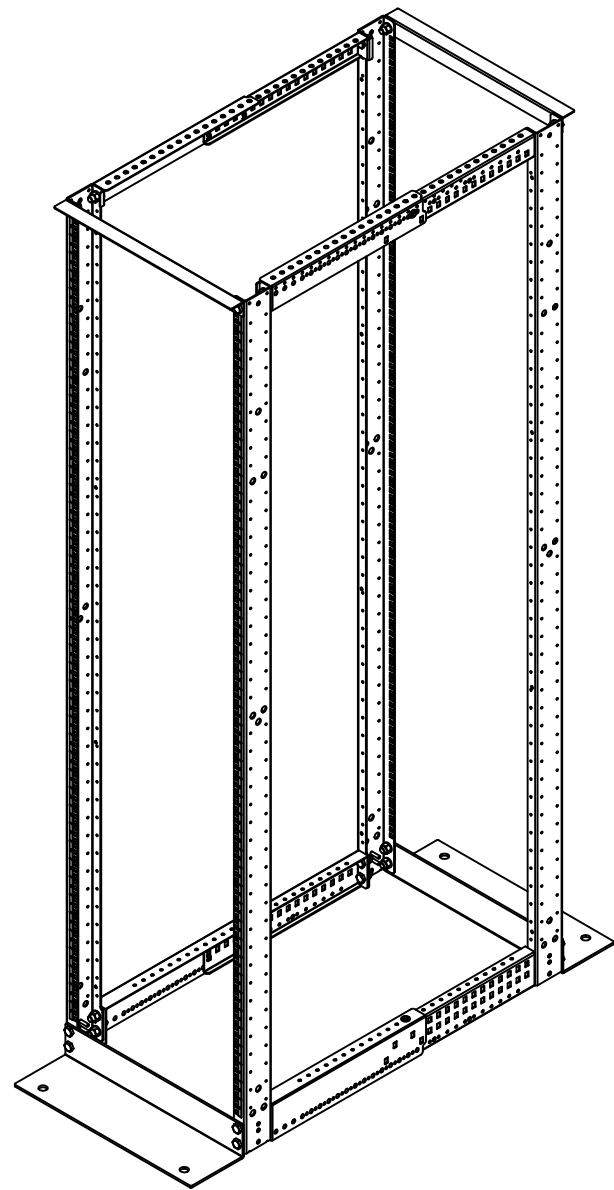

**TOE OUT MOUNTING  
ISOMETRIC VIEW**

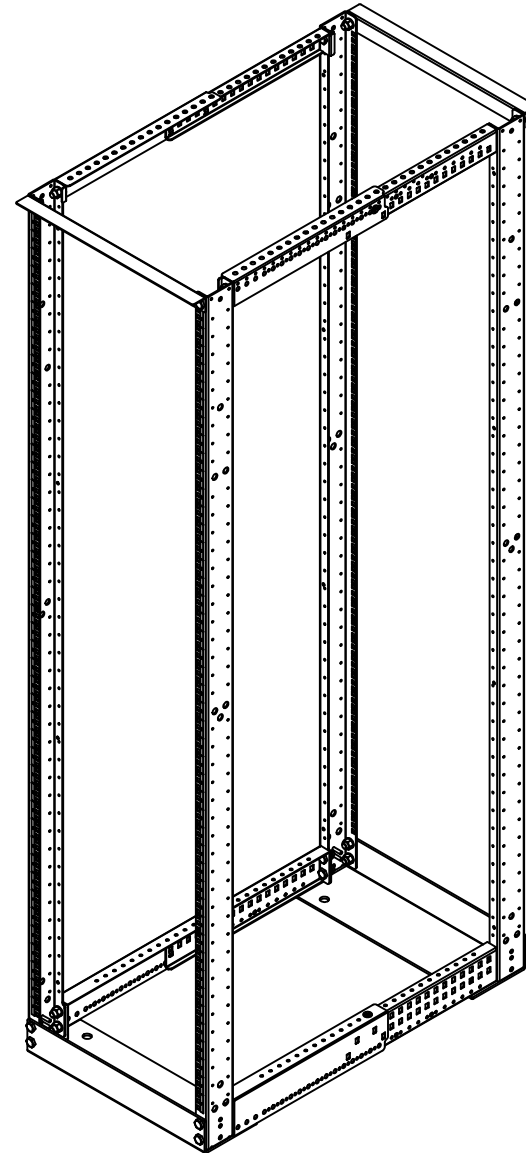

**TOE IN MOUNTING  
ISOMETRIC VIEW**

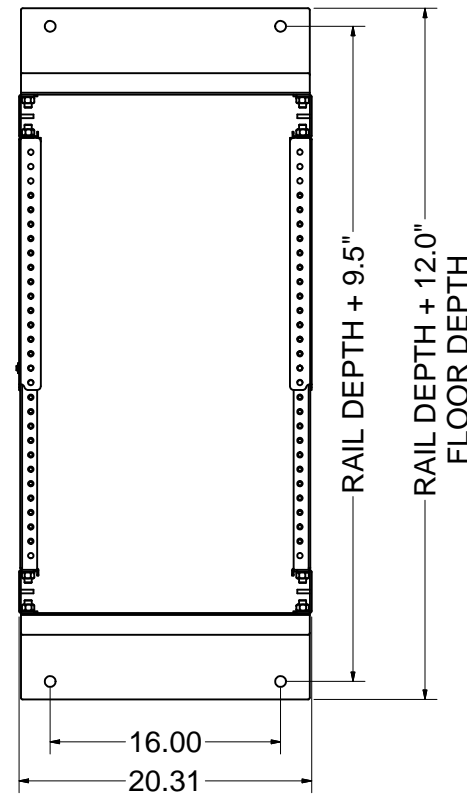

**TOE OUT MOUNTING  
TOP VIEW**

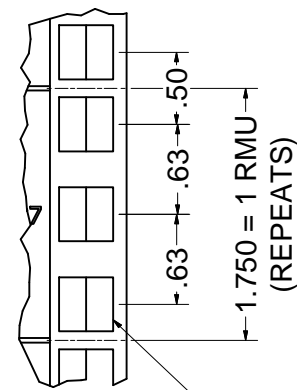

**DETAIL E**

0.375" □, TYP.  
CAGE NUT  
MOUNTING  
HOLE

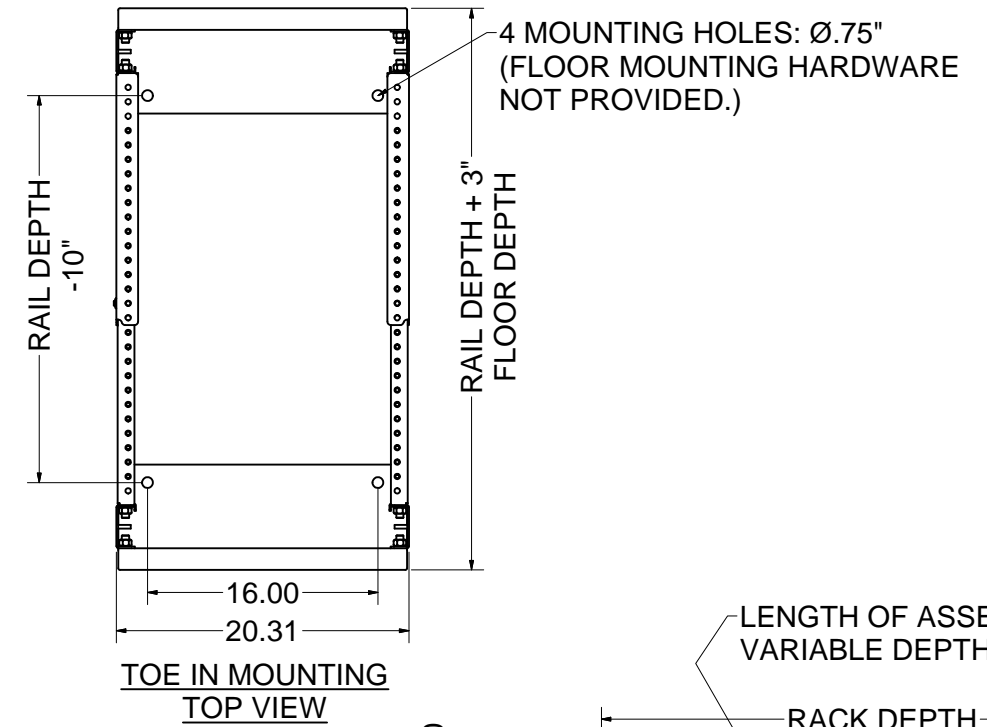

**TOE IN MOUNTING  
TOP VIEW**

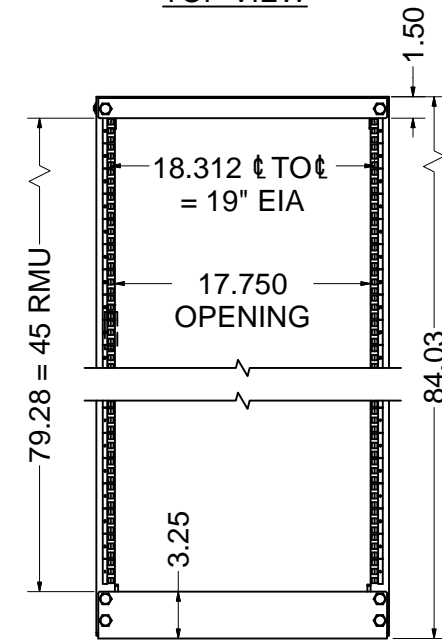

**FRONT VIEW 19" EIA MTG.**

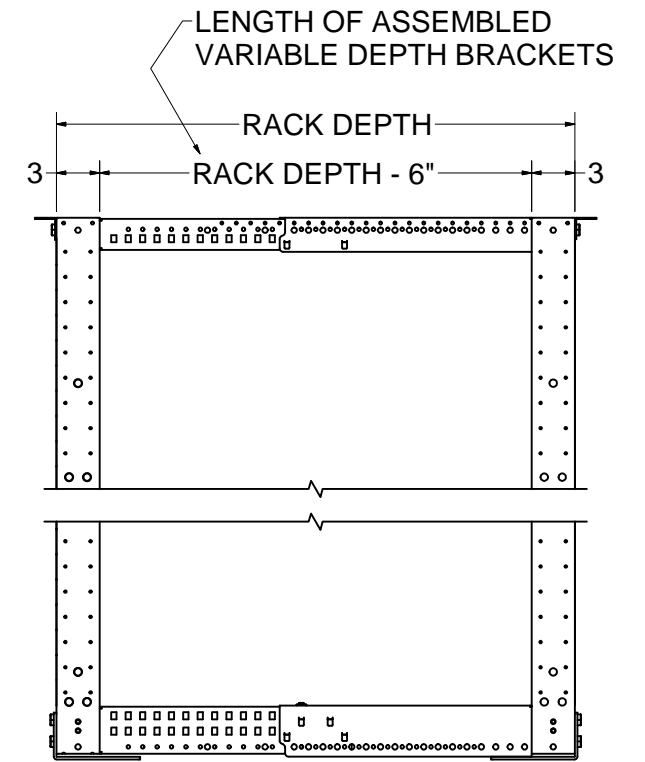

EST. WEIGHT :  
93.80 lbmass

THIRD ANGLE  
PROJECTION

INTERPRET DRAWING PER ASME Y14.5M-1994
DIMENSIONAL LIMITS APPLY AFTER APPLICATION OF FINISH
DRAWING NOT TO SCALE
TOLERANCE UNLESS OTHERWISE NOTED:
ANGULAR +/- 1°
.XXXX +/- .010
.XXX +/- .015
.XX +/- .030
.X FOR REF. ONLY
UNLESS OTHERWISE SPECIFIED ALL DIMENSIONS ARE IN INCHES

**NOTICE:**

Use of this document is subject to a confidentiality and nondisclosure agreement with Great Lakes Case & Cabinet Co., Inc. (GLCC) and may not be reproduced, disclosed or utilized in whole or in part without prior written authorization from GLCC.

PART NUMBER: VD4PM6-2436
QTY PER UNIT: 1
MATERIAL TYPE:
MATERIAL GAUGE:
FINISH:
DRAWN DATE PCS 1/27/2014
CHECKED & APP. DATE

TITLE <b>VARIABLE DEPTH 4 POST RACK (M6)</b>
GREAT LAKES CASE & CABINET CO., INC. P.O. BOX 551 EDINBORO, PA 16412 PHONE (814) 734-7303 FAX (814) 734-3907 E-MAIL glcc@greatcabinets.com
DWG NO. REV SHEET: 1 OF 1